

PRESSURE COOKERS

ALUMINIUM

0

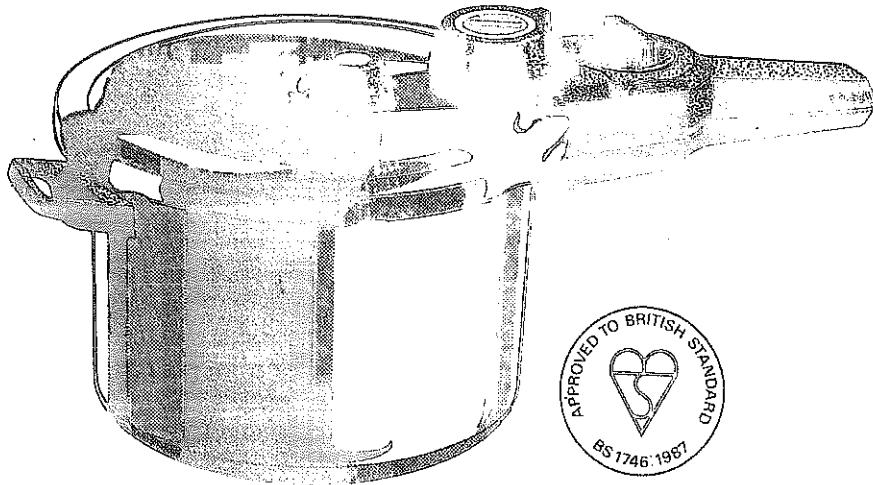

PRESSURE COOKER WITH RISE 'N' TIME
INDICATOR, REMOVABLE TIMER AND
AUTOMATIC STEAM RELEASE
MODEL 2025/2020

PLEASE READ THESE INSTRUCTIONS CAREFULLY
BEFORE USING YOUR PRESSURE COOKER.
ALWAYS USE YOUR COOKER IN ACCORDANCE
WITH THESE INSTRUCTIONS.

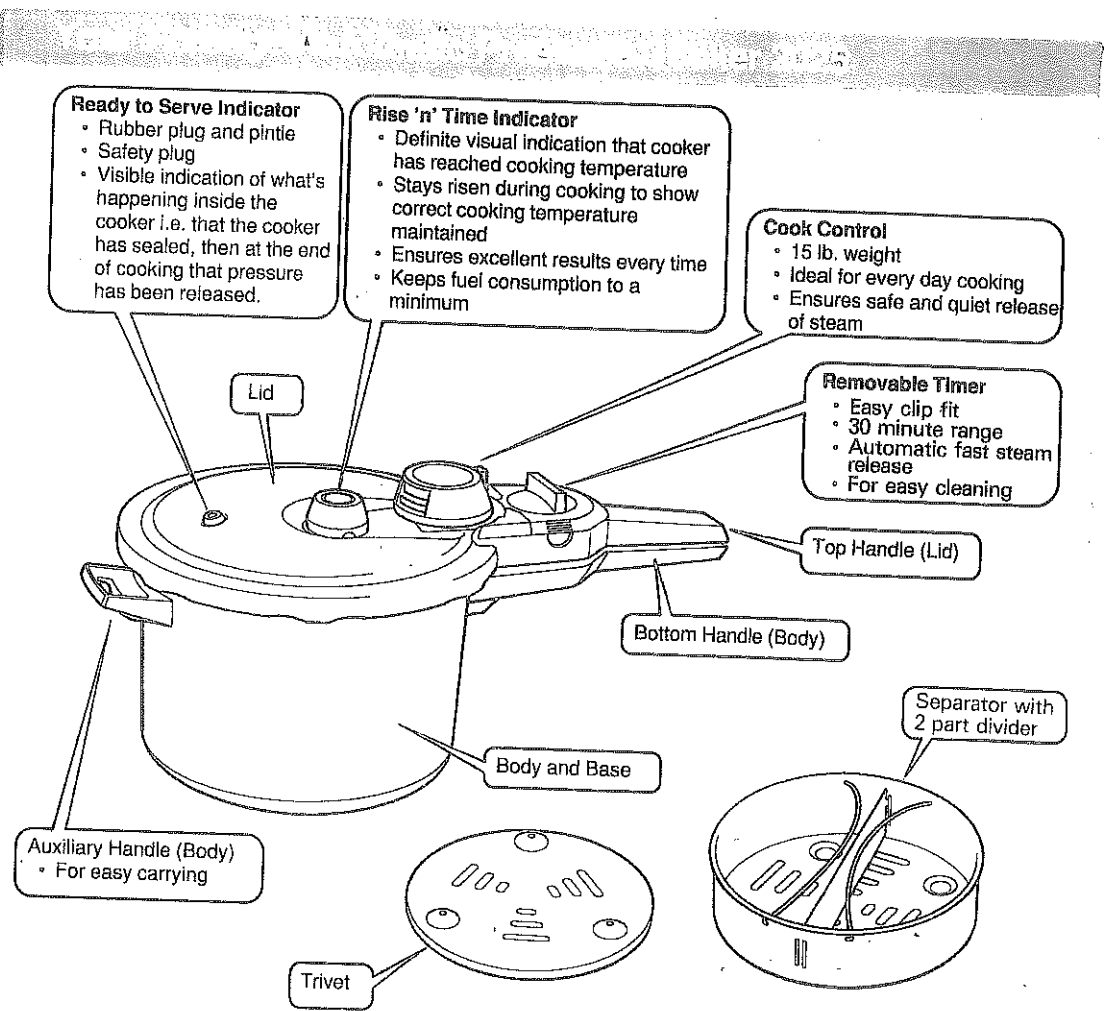

Overall volume 5.3 litres (9 1/4 pts.)

Body capacity 5 litres (8 3/4 pts.)

Maximum cooking quantities

1 litre (2 pts.) liquid before the meat, vegetables, etc. are added
2 kg. (4 lbs.) joint

Features

- Cook Control 15 lb. (nominal operating pressure of 103 kPa/15 p.s.i.) (10 lb. weight available for jam making/blanching)
- Ready to Serve Indicator incorporating safety plug
- Rise 'N' Time Cooking Indicator
- Automatic fast steam release
- 30 minute timer - removable

Accessories included

- Colour recipe book
- Instruction leaflet
- Trivet
- Separator

Suitable for gas and radiant ring (electric).

Fitting the Removable Timer

1. Carefully grasp timer. Insert timer into position in top handle.

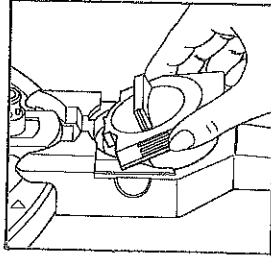

2. Press down until it clicks into place.

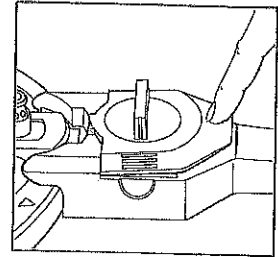

Fitting the Cook Control

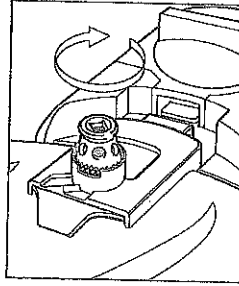

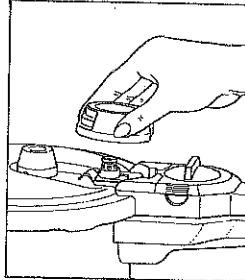

1. Check Cook Control support is finger tight.

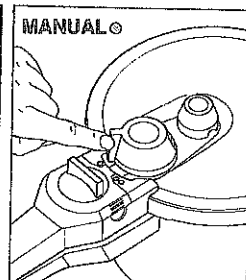

2. Press Cook Control into place with slots towards lid centre.



3. It should click into support and move freely between MANUAL  and  AUTO.

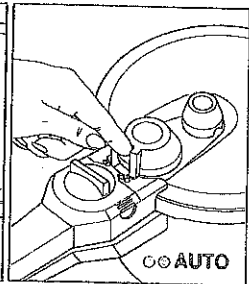

Check the Ready to Serve Indicator

Ensure the pintle of the Ready to Serve Indicator moves freely and its rubber plug is seated correctly.

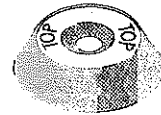
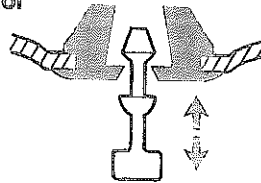

Your Prestige pressure cooker is now ready, but first try putting on and removing the lid.

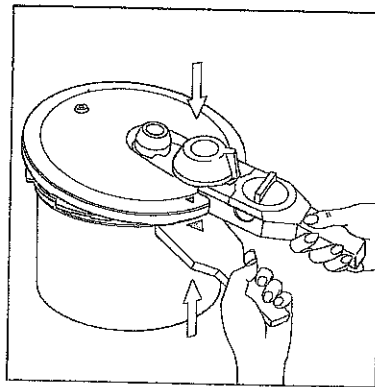

1. Hold the lid at a slight angle.

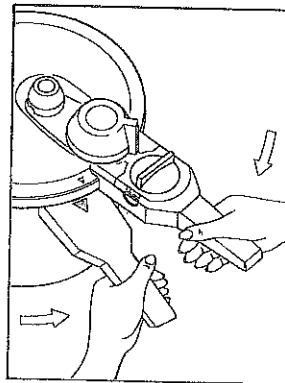

2. Place the lid over the body and line up the arrows. Press down on the lid opposite the handle.

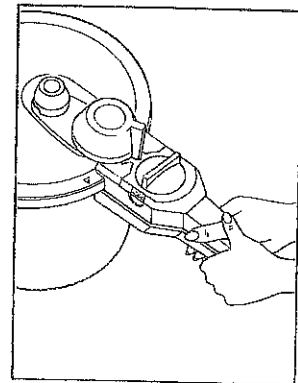

3. Slide the handles together. Remove lid by sliding handles apart.

Caution: Always ensure the cooker is fully closed with the top and bottom handles in line.
Note: Prestige cookers are made to fine tolerances. Sometimes a new lid may be a little stiff. To help this smear a little cooking oil around the gasket and the rim of the lid.

Handy Hints When Using Your Prestige Pressure Cooker

Before using your cooker for the first time, remove the timer and wash the cooker in hot soapy water (see CLEANING AND CARE). Always use it in accordance with Prestige instructions.

Heat sources and settings

- Your Prestige cooker is suitable for use with gas, and radiant ring (electric).
- It is not suitable for ceramic, halogen, solid electric and induction hobs.
- Always follow the hob manufacturer's instructions.
- Use the largest diameter area available.
- DO NOT allow gas flames to spread up side walls of body.
- Never slide the pressure cooker on a ceramic hob. Always lift it on and off.
- Foods which may froth up, e.g. rice, pasta, cereals, pulses and beetroot, should be brought to pressure on a medium heat and depressurised slowly. Note this also applies to milk which froths up when heated.

Liquids you can use for cooking

- Any liquid which produces steam when boiled can be used in the cooker. Examples are water, stock, wine, milk.
- Never use oil or melted fat as a cooking liquid. They may be used in small quantities for browning ingredients.

Adding the liquid for cooking

- You must always add a minimum of 250 ml (1/2 pt.) of liquid to the cooker - NEVER LESS. This quantity covers the first 15 minutes of pressure cooking.
- A further 125 ml (1/4 pt.) of liquid must be added for each additional 15 minutes or part of 15 minutes of cooking. For example, 625 ml (1 1/4 pts.) is necessary for 1 hour.

Caution: DO NOT overfill the cooker. Remember there are different maximum filling levels for different foods.

Follow these guidelines:

Cereals and pulses; dried peas, beans and lentils* cooker should not be more than	1/3 full
Liquid foods; soups, stews, rice, pasta, also beetroot cooker should not be more than	1/2 full
Solid foods; vegetables, one pot meals, joints* cooker should not be more than	2/3 full

* This includes liquid too.

- If you use your own containers in the cooker, make sure they can withstand 130°C (262°F).
- DO NOT place containers on top of foods which may froth up such as rice, pasta, cereals, pulses and beetroot.
- Ensure container covers (e.g. greaseproof paper, foil or cloth) are securely fastened with string and cannot come off during cooking.
- DO NOT fit containers with metal or plastic lids.
- Never cook dumplings under pressure or the dough will rise and could block the safety outlets. Place the dumplings in the hot stew and cover with the cooker lid but DO NOT close.
- Take care not to damage the body rim when stirring soups, stocks or mashing potatoes.

Let's Now Use the Pressure Cooker for a Simple Recipe...

Boiled Potatoes - Cooking time 4 minutes.

1. Add 250 ml (1/2 pt.) of water to the cooker.
2. Place the trivet rim side down in the cooker.
3. Place 400g (1 lb.) peeled potatoes cut to 25g (1 oz.) pieces in the separator. Place into the cooker.
4. Place the lid on and close it.

Caution: Always ensure the cooker is fully closed with top and bottom handles in line.

5. Place the Cook Control (15 lb.) on its support. Make sure it clicks into place. You can see there are 2 positions. Your recipe book will tell you which setting to use for each recipe. MILK AND FOODS WHICH MAY FROTH UP, e.g. RICE, PASTA, PULSES, CEREALS, BEETROOT AND SOME SOUPS MUST BE DEPRESSURISED SLOWLY BY TURNING TO MANUAL ☉.

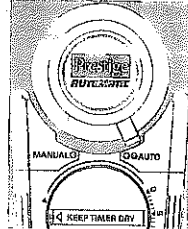

1. **Automatic**
When Cook Control is set to ☉☉ AUTO the steam will be quickly and automatically released after cooking.

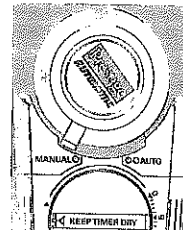

2. **Manual**
When Cook Control is set to MANUAL ☉ the steam will be cooled slowly after cooking. This will take approximately 10-15 minutes.

6. For this recipe (potatoes) turn the Cook Control to ☉☉ AUTO.
7. Turn the timer clockwise to SET TO BOIL.

8. Check the Ready to Serve Indicator is down. 

9. Place the cooker on the heat source and turn to a high setting.

Caution: Use a medium setting for foods like rice, pasta, cereals, pulses and beetroot which may froth up, or when cooking with milk.

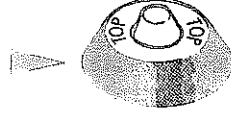
10. Wait for steam to come from the centre of the Ready to Serve Indicator. The centre pintle will then rise and seal the hole. Steam is now sealed in the cooker and the temperature will rise. 

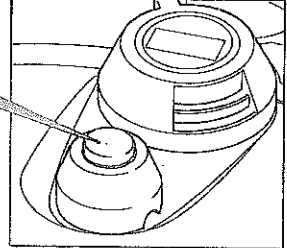
11. The silver part of the Rise 'N' Time Indicator will then rise. This shows the correct cooking temperature has been reached. 

12. When the Rise 'N' Time Indicator has risen, wait 10 seconds before lowering the heat source or the Indicator may drop.

13. Set the timer to 4 minutes by turning it anti-clockwise. NOW THE COOKING TIME BEGINS.

14. During cooking, make sure that the silver Rise 'N' Time Indicator remains risen.

- If the heat setting is too high - a continuous loud escape of steam will come from the Cook Control. Lower the heat setting - you are wasting fuel!
- If the heat setting is too low - caused by the heat being lowered too quickly or by too much, the Rise 'N' Time Indicator will drop. Increase the heat setting until the silver part of the Rise 'N' Time Indicator appears. Wait 10 seconds and then turn the heat down.

Add a little extra cooking time to compensate for time when the temperature inside the cooker was too low, or the potatoes will be undercooked.

After a few uses you will find just the right heat setting for your hob.

15. After 4 minutes the timer reaches 0 and the bell rings.
16. Turn off the heat.
17. When the bell stops the Cook Control releases the steam automatically and quickly.



Note: when the recipe states MANUAL  leave the cooker to cool - this will take 10-15 minutes depending on the recipe.



18. The Rise 'N' Time Indicator will drop.
19. Wait until the pintle of the Ready to Serve Indicator has dropped. This shows that the cooker has depressurised, all steam has been released and the lid can be opened.
20. Slide the top and bottom handles apart.

Caution: If resistance is felt, ensure that the heat source is off and that the pressure has been fully released. DO NOT force.

Now why not try one of the recipes included in the recipe book supplied with your cooker, or adapt one of your own recipes following the notes in the recipe book.

All steamed puddings contain a raising agent to make them light. A short pre-steaming time is necessary before cooking so that the raising agents are able to work. Without pre-steaming they will be heavy and close textured. Assuming your ingredients are ready in the cooker and the lid is on, proceed as follows to steam.

1. Do not set the timer.
2. Remove the Cook Control completely.
3. Check that the centre pintle in the Ready to Serve Indicator is down.
4. Place the cooker on a high heat. Wait until there is a steady flow of steam from the Cook Control support and the Ready to Serve Indicator.
5. Reduce the heat to maintain a steady flow of steam.
6. Set the timer for the steaming time recommended in the recipe (e.g. 5 minutes for pineapple upside down pudding).
7. When the timer rings place the cook control on the support. Push it down until it clicks into place.
8. Turn the Cook Control to either: MANUAL  for slow release of steam or  AUTO for quick release of steam depending on the recipe. (Slow for pineapple upside down pudding.)
9. Turn the heat to high and turn timer to SET TO BOIL position to bring to temperature.
10. When the Ready to Serve Indicator has sealed and Rise 'N' Time Indicator risen, set the timer according to the recipe cooking time. (7 minutes for pineapple upside down pudding.)
11. Release the steam according to the recipe.

1. Bring the cooker to temperature in the normal way with the Cook Control on MANUAL  and set 30 minutes on the timer.
2. When the timer bell rings, leave the heat on and reset the timer for the extra time, e.g. 20 minutes.
3. If the recipe requires quick release of steam at the end of cooking, quickly turn the Cook Control to  AUTO after you reset the timer.

(There will be a slight escape of steam.)
If the food requires slow release of steam at the end of cooking, leave the Cook Control in the MANUAL  position.

4. Continue as for normal pressure cooking.

Caution: Remember to add the correct amount of water for a longer cooking time.

Cleaning and Care of Your Pressure Cooker

CAUTION: DO NOT WASH YOUR COOKER IN A DISHWASHER. ALWAYS REMOVE THE TIMER FROM THE TOP HANDLE BEFORE CLEANING ANY PART OF THE LID. THE TIMER MUST BE KEPT DRY AND NEVER IMMERSUED IN WATER OR PUT IN A DISHWASHER. DO NOT WASH THE GASKET MORE THAN NECESSARY IN DETERGENT - IT SHORTENS ITS LIFE

Body, Trivet and Separator

After every use

- wash in hot soapy water and rinse and dry thoroughly.

Interior staining

- occasionally food may stick to the interior. To remove use a plastic scrubbing brush or steel wool pad.
- to prevent discolouration, add a little lemon juice or vinegar to the water when cooking in containers.
- if discolouration occurs, don't worry, it is harmless. Remove either with a steel wool pad or by simmering without the lid for 20 minutes with a strong solution of water and either cream of tartar, vinegar, lemon juice or apple peelings.

Caution:

- the aluminium will lose its appearance by using soda for cleaning or if it is left in hot soapy water for long periods.
- do not use abrasives on the mirror polished exterior.
- never leave food in the cooker for long periods. Remove it as soon as possible or pitting of the metal may occur.

Lid

Caution:

- always remove the timer from the top handle before cleaning any part of the lid.
- the timer must be kept dry and never be immersed in water or put in a dishwasher.

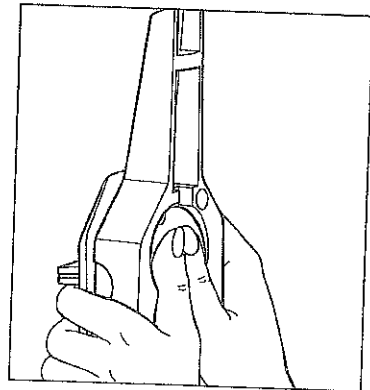

To remove timer

- gently push timer base from underneath the handle.

After every use

- if food has boiled up and the inside of the lid is soiled, remove gasket and wash lid in hot soapy water, then wipe lid and gasket with a well rung out damp cloth to remove moisture.
- remove Cook Control and check centre support of Cook Control is clear. If blocked in any way, wash in hot running water using a pipe cleaner or skewer if necessary.
- clean Cook Control. Run warm water through Cook Control slots and leave to drain.
- check Rise 'N' Time and Ready to Serve Indicators move freely.
- replace Cook Control.

Cleaning the Rise 'N' Time Indicator

The Rise 'N' Time Indicator will not need to be cleaned after every use. If it sticks because food or liquid has leaked into it, clean it as follows

- gently lever off the Indicator's cap with the end of a teaspoon or similar.
- lift out the Rise 'N' Time Indicator.
- wash and dry the Indicator taking care not to bend the stem.
- use a dishwashing brush to clean round the cover's retaining clip and the Indicator housing.
- dry thoroughly, insert the Rise 'N' Time Indicator and press the cover back into place.
- make sure the Rise 'N' Time Indicator moves up and down freely..

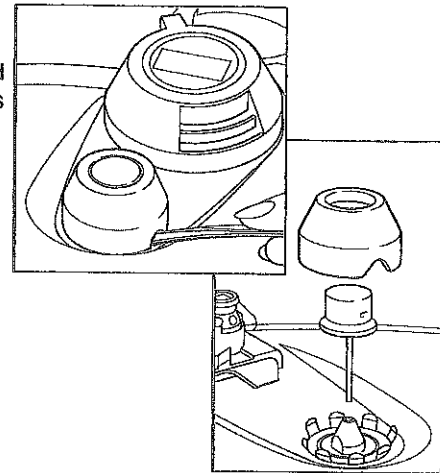

If it is necessary to remove the retaining clip and Indicator housing for cleaning, this can be done by unscrewing the nut inside the lid using pliers or similar. When re-assembling, make sure the nut is tight.

Cleaning the Cook Control Support

If the cooker becomes badly soiled, the Cook Control Support and Camseat can be removed for cleaning. Take care to hold both together as they are removed to prevent them springing apart. Do not lose the 'O' rings.

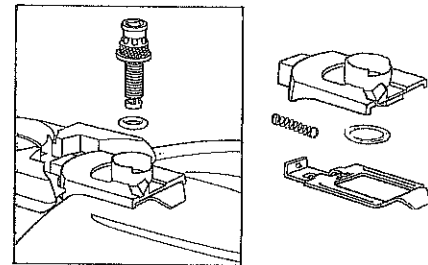

Replacing the Ready to Serve Indicator

1. Push old rubber plug inwards from outside the lid.
2. Insert new valve from inside the lid. The top of the valve is marked. The word 'TOP' should be visible from the outside of the lid.
3. Ensure metal pintle in the centre is down.

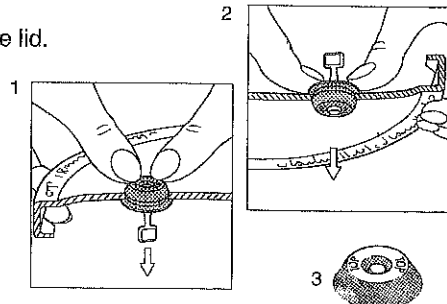

Storage

- make sure the cooker, trivet and separator are thoroughly dry before storage, this prevents pitting of the metal.
- always leave the cooker open to allow air to circulate, to avoid mustiness.
- never reverse the lid into the body, it may scratch the finish.
- be careful not to store the body where its rim can be dented or nicked by other utensils, such damage may prevent the gasket sealing and stop the cooker functioning correctly.
- if the cooker is not used for a prolonged period, check that the gasket and Ready to Serve Indicator have not hardened. If hardened they will not form a seal and should be replaced if there is any doubt.

WHAT TO DO IF	POSSIBLE CAUSE	ACTION	ADVICE
Cooker will not come to pressure	Ready to Serve Indicator leaking	Renew Ready to Serve Indicator	See SPARE PARTS
	Lid gasket leaking	See 'Lid gasket leaks'	
	Cook Control not clicked into place or loose	See 'Excess steam from Cook Control' Check correct position of Cook Control	
Lid gasket leaks	Timer not turned to 'Set to Boil' position	Turn timer to 'Set to Boil'	
	Dirty gasket or food particles on the rim	Wipe cooker rim and gasket	A gasket is expected to last 9-12 months with normal use
	Worn or hardened gasket	Replace with new gasket immediately	
	Damaged body or lid	Return Cooker to Prestige Customer Care Dept.	Ensure careful handling and storage
Excess steam from Cook Control	Heat is too high	Turn heat down	Make sure Rise 'n' Time Indicator remains up
	Cook Control is not fully clicked into position	Click Cook Control into position using an oven glove or wait until cooker is cool	
	Cook Control Support is loose	Cool, remove lid and tighten Cook Control Support	
Rise 'N' Time Indicator will not rise	Lid gasket leaking	See 'Lid gasket leaks'	A Ready to Serve Indicator is expected to last 9-12 months with normal use.
	Ready to Serve indicator leaks	Replace Ready to Serve Indicator	
	Stem of Rise 'N' Time Indicator is bent	Check, remove and replace	See SPARE PARTS
	Rise 'N' Time Indicator needs cleaning	Check and follow cleaning procedure	See CLEANING AND CARE
	Rise 'N' Time nut is loose	Check and tighten	
Rise 'N' Time Indicator falls after rising	Heat setting reduced too quickly after Rise 'N' Time Indicator rose	Increase heat, wait 10 seconds until Indicator rises and reduce heat	
	Heat setting reduced too far	Increase heat	Adjust until Rise 'N' Time Indicator stays up
Ready to Serve Indicator pintle rises and ejects steam vertically	Cook Control Support blocked and cannot vent correctly	Cool, clean Cook Control Support. Re-set Ready to Serve Indicator Pintle	See CLEANING AND CARE
Ready to Serve Indicator blows out completely	Cook Control Support blocked and cannot vent correctly	Cool, clean Cook Control Support. Fit a new Ready to Serve Indicator	See SPARE PARTS
Cooker boils dry	Lid gasket leaking		See CLEANING AND CARE
	Ready to Serve Indicator leaking		<i>Caution: If the cooker boils dry it will overheat and may become distorted. Overheating may cause the centre pin of the Ready to Serve Indicator to melt</i>
	Excess steam from Cook Control	Check and return to Prestige Customer Care Dept. if necessary.	<i>Distortion of the cooker base is not covered by the Prestige guarantee</i>
	Cooking on too high a heat for too long		
	Insufficient liquid for the cooking time		

Safety

Your cooker is safe if used properly. It has been designed and produced in accordance with British Standards. We have also built in a number of unique safety features.

1. Gasket offset device.

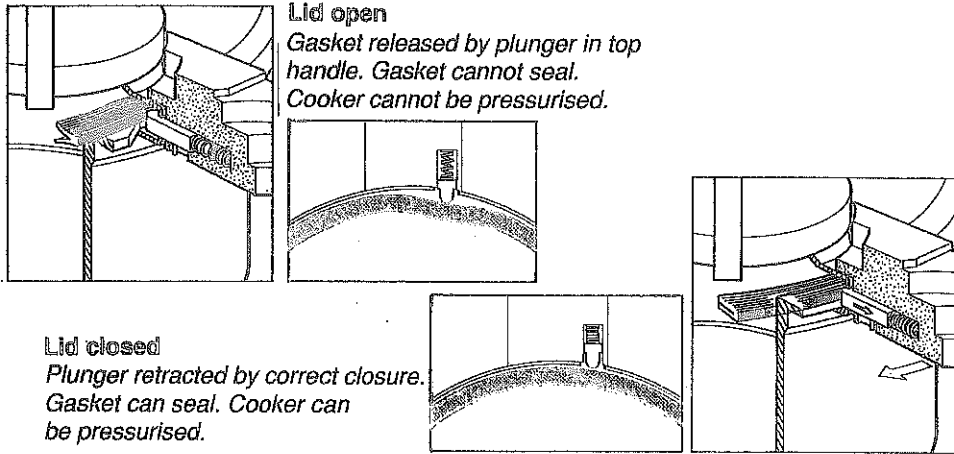

This ensures that the cooker cannot come to pressure until the lid is correctly closed.

2. Locking lugs on cooker body.

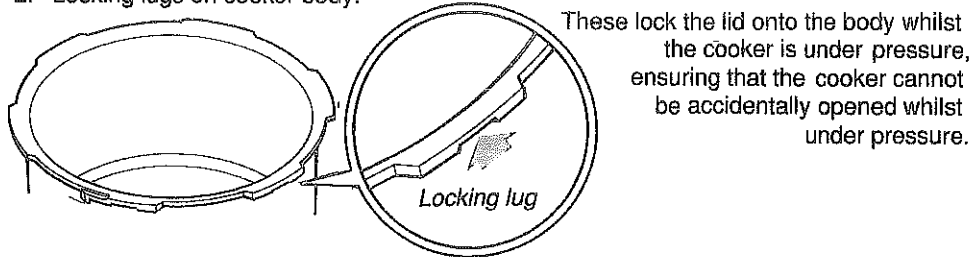

3. Ready to Serve Indicator acts as a safety valve giving 3 separate levels of protection.

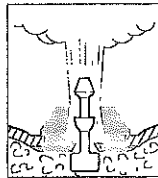

If there is a build up of excess pressure in the cooker, the metal pintle will pop up allowing vertical release of steam through the centre hole. This will reduce the pressure.

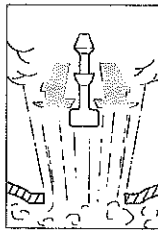

If the excess pressure is not reduced then the whole of the rubber safety plug will blow out. This will allow a vertical release of steam to reduce the pressure.

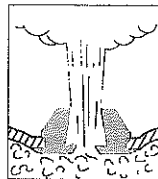

If the cooker boils dry or becomes too hot, the metal pintle in the centre of the indicator will melt allowing the excess pressure to be released.

Caution: If cooker boils dry DO NOT attempt to move the cooker until it has completely cooled.

Spare Parts - Prestige Automatic Pressure Cooker Model No. 2025

All Prestige cooker parts are replaceable should they be damaged or lost. **Only Prestige replacement parts must be used.** The use of other makes of spares will invalidate the guarantee and may be very dangerous. Remember to quote the stock number and description as shown in the diagram. These spares are available at major pressure cooker stockists. If you have any difficulty in obtaining them, please apply to our Customer Care Department; address and phone number given below. Remember the gasket and Ready to Serve Indicator should be replaced every 9-12 months.

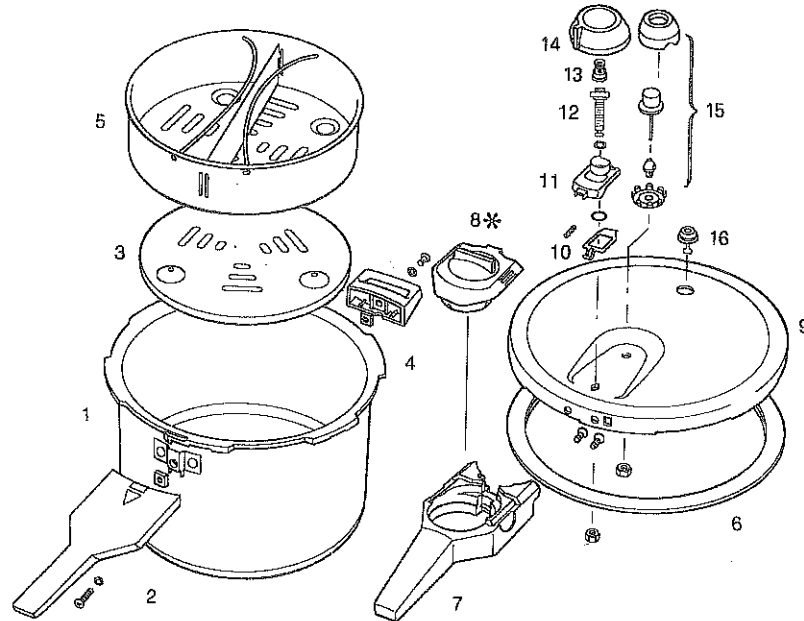

2025 Automatic

(Nominal operating pressure 103 kPa/15 p.s.i.)

1. Body	96415	* 8. Removable timer	92127
2. Bottom handle and screw	92125	9. Lid	96139
3. Trivet	96450	10. Camseat Sliderplate	96131
4. Auxiliary handle	96431	11. Camseat	96132
5. Separator	96005	12. Centre Vent	99517
6. Gasket	96430	13. Cook Control Support	99887
7. Top handle & screw (excluding timer)	92129	14. Cook Control	96438
		15. Rise 'N' Time Indicator	92126
		16. Ready to Serve Indicator	96410

*** Caution: Always keep timer dry - remove before washing any other part of the cooker. Should the timer be faulty, return it separately for service**

WARNING!
ON NO ACCOUNT SHOULD ANY OF THE SAFETY DEVICES USED ON THIS
COOKER BE TAMPERED WITH OR ALTERED

Prestige Cookers are guaranteed by the manufacturer for 10 years from the date of purchase and will during this period be replaced or repaired free of charge if there is any defect due to faulty materials or workmanship. This guarantee does not cover defects occurring due to abuse or normal wear and tear. Some parts (e.g. gasket and Ready To Serve Indicator) require periodic renewal and as such are not covered under the guarantee. Any person claiming under this guarantee should send the Pressure Cooker direct to:

**Prestige Group Customer Care Department,
P.O. Box 95,
Colne Road,
Burnley BB11 2AD,
Tel.No. 0282 831016**

Please state

1. Name and address (Block Capitals) 2. Date of purchase 3. Name and address of supplier.

Part No. 2025/1
Material Code 4202508